

ORIGINAL VERSION



**S1 / S1 DHC Electric Trolley
Instruction Manual**

EN

REGISTER ONLINE
www.motocaddy.com/warranty

Visit www.motocaddy.com/instructions for other Motocaddy instructions including translations

Locating your Serial Number / Information about DHC

This Motocaddy electric trolley is designed for the transportation of golf bags and clubs contained within.

Locating your Serial Number

The serial number for this S-Series trolley is located on the trolley underside on top of the motor (fig. 1). This number is required when registering your warranty online and should be kept handy for future use.

The same number should also be on the box received with your trolley. Please ensure you keep hold of the packaging in case you need to return your trolley for any reason. A proof of purchase must also be kept in case your trolley requires servicing during its warranty period.

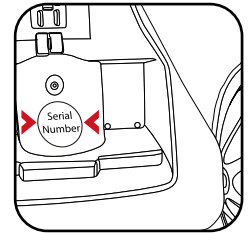

Fig 1

Please keep a record of your trolley serial number here for future reference:

M	C	S												
---	---	---	--	--	--	--	--	--	--	--	--	--	--	--

Information about DHC (Downhill Control) models

The information in this instruction manual applies to both standard and DHC electric trolley models. For DHC specific functionality, please turn to page 19.

1. Folding Release Latch
2. LCD Display Screen
3. On/Off & Speed Control Button
4. USB Port (on underside of handle)
5. Pop-Up Charging Port
6. Battery Release Catch
7. Battery
8. Rear Wheels
9. Rear Wheel Release Catch
10. Front Wheel
11. Front Wheel Adjuster
12. EASILOCK Lower Bag Support
13. Lower Bag Support Strap
14. Upper Bag Support

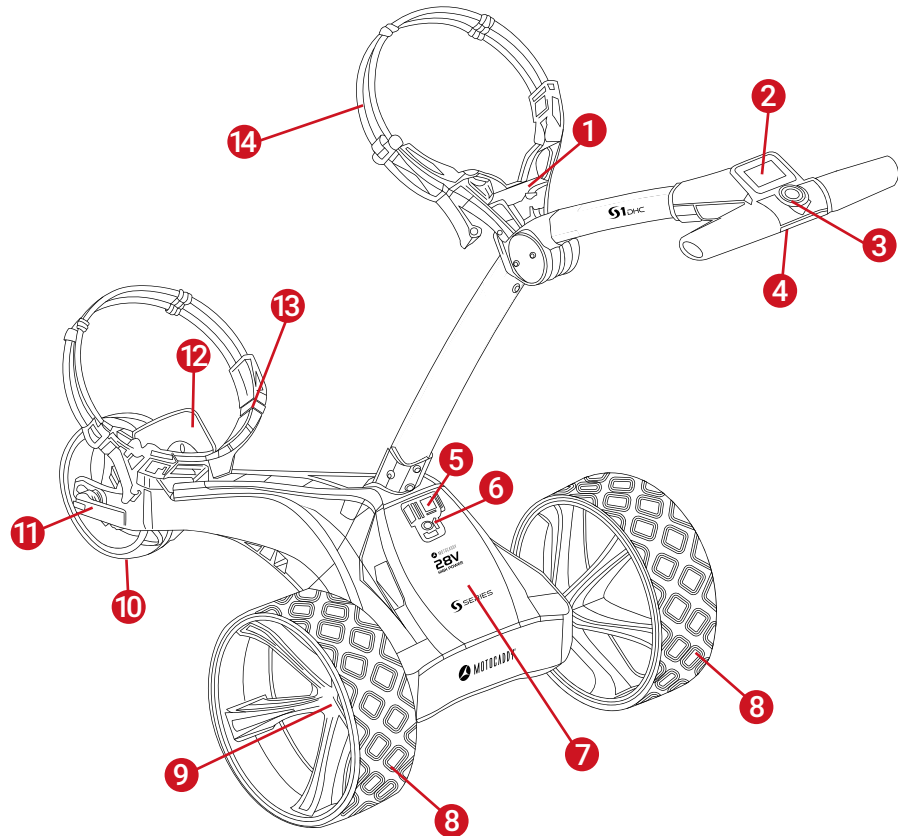

Safe use of your Trolley

Safety cut-out

This Motocaddy trolley is fitted with a timed safety cut-out feature. Once started, the trolley will automatically cut power to the motor after ten minutes to reduce the risk of damage to the trolley. Pressing the On/Off button will restart the trolley.

Safe use of your Trolley

Motocaddy trolleys are designed for the transportation of golf bags and clubs contained within. Using the trolley for any other purpose may cause damage to the trolley and cause harm to the user.

- Do not attempt to transport any other equipment;
- The trolley is not designed for the transportation of people;
- The maximum rated load suitable for this trolley is 20kg;
- Do not use the trolley to assist you when walking up hills;
- Submerging the trolley in water (e.g. a lake) is likely to cause damage to the trolley;
- Do not operate the trolley whilst under the influence of drugs or alcohol;
- This trolley can be used by children aged from 8 years and above and persons with reduced physical, sensory or mental capabilities or lack of experience and knowledge if they have been given supervision or instruction concerning use of the trolley in a safe way and understand the hazards involved. Children shall not play with the trolley. Cleaning and user maintenance shall not be made by children without supervision;

Caring for your Trolley

Although your Motocaddy trolley has been weatherproofed, please follow these simple guidelines to help protect your trolley:

- Do not store your trolley outside;
- Try to minimise exposure to rain as much as possible with an umbrella during heavy rainfall;
- Wipe excess water from the trolley prior to storage;
- Never use a pressure washer to clean your trolley. To prevent water damage, wipe down with a damp cloth;
- Avoid using high pressure air hoses near moving components;

This Motocaddy trolley is designed to require very little maintenance. We do however recommend checking your trolley before each use to ensure:

- There is no build up of excess mud and dirt;
- The rear wheels are securely fitted and turn freely;
- The front wheel nut is on tightly and quick release lever is clamped down;
- The front wheel is not clogged up and turns freely;

Only original Motocaddy parts should be used when repairing your trolley.

If you experience an issue with your trolley, please contact our Technical Support team for further assistance.

Important Battery Safety & Care Information

- Always recharge as soon as possible after finishing your round, regardless of the number of holes played - ideally within 12 hours. Leaving batteries uncharged for extended periods may reduce capacity and could void your warranty;
- Never leave batteries charging for longer than necessary - disconnect once the green LED light indicates the battery is fully charged;
- Ensure that only Motocaddy 28V Lithium batteries are charged with Motocaddy 28V Lithium battery chargers (Model LC-2323) and the charger is always connected to an earthed socket outlet;
- Batteries must be stored and charged on a dry, non-carpeted surface at a temperature ranging between 10°C and 30°C - charging outside these temperatures may reduce capacity;
- The battery and charger must only be opened and maintained by authorised personnel. Unauthorised opening increases the risk of safety issues and will invalidate your warranty;
- Take care not to drop the battery as this may cause damage to the internal cells which could affect battery performance and safety;
- Regularly check the battery for visible signs of damage. Do not charge or use the battery if any damage is suspected - contact our Technical Support team immediately for advice;
- Use a damp cloth to clean off any dirt, but try to avoid getting the battery too wet (i.e. do not submerge, avoid deep puddles & do not clean your trolley with the battery in the tray);
- **WARNING:** For the purposes of recharging the battery, only use the detachable supply unit provided with this trolley;
- If the supply cord is damaged, it must be replaced by Motocaddy, authorised Service Agents or similarly qualified persons to avoid a hazard;

- The battery supplied with this trolley contains battery cells that are non-replaceable;
- Only battery models 28.8V High Power 198Wh & 28.8V High Power ULTRA 274Wh can be used with this trolley;
- Exhausted batteries are to be removed from the trolley and safely disposed of;
- If the trolley is to be stored unused for a long period, the battery should be removed;
- The battery supply terminals must not to be short-circuited;

IMPORTANT - As with any electrical device, it is not recommended to leave batteries charging overnight or for prolonged periods without supervision. Our Lithium batteries can be fully-charged from empty in less than 5 hours, so wait for the charger light to turn green, switch off at the wall and unplug the battery ready for your next round.

WARNING - If the charger LED light flashes RED and/or GREEN consecutively when connected to the battery, this indicates there is likely to be a fault with the battery or charger. It is important that you disconnect the charger immediately and contact our Technical Support team for further assistance. Do not attempt to use the battery or charger as this could pose a significant safety risk which could result in fire.



We are dedicated to protecting the environment and encourage the recycling of Motocaddy products. Exhausted and damaged batteries should be safely disposed of through a local recycling point (where available). Alternatively, please contact our Customer Support team for further information regarding safe and responsible disposal.

Charging your Lithium Battery

Charging your Lithium Battery

The Lithium battery can be left on the trolley or removed for charging. It is possible to charge the battery while the trolley is folded or unfolded. If folded, the charging port will become automatically accessible (fig. 1). If removing the battery for charging, slide the battery release catch to the left (fig. 2) and lift the battery using the two grab handles provided (fig. 3). If the charging port is not visible - for example when the trolley is unfolded or battery has been removed - it can be pulled out manually.

1. Plug the Motocaddy 28V Lithium battery charger into an earthed mains power socket
2. The charger light will be GREEN when not attached to a battery to indicate that it is ready to charge
3. Attach the charger cable to the charging port, matching the black and grey connections
4. The charger light will provide an indication of charging phase:
 - RED - Battery charging
 - GREEN - Battery fully charged
5. The charging process will take between 3 to 5 hours depending on the depth of discharge. This may take longer for the first few charges
6. Once charging is complete, disconnect the charger from the mains power supply and battery
7. The charging port will need to be pushed into the battery to switch the power on for next use

If you connect the battery to the charger and the light goes out, this is likely to indicate that the battery is fully charged. Please double check the battery on the trolley to ensure that it is fully working. If the light flashes RED and GREEN consecutively, this indicates there may be a fault with the charger.

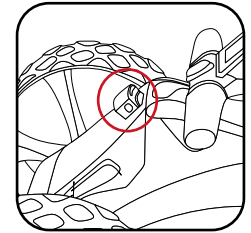

Fig 1

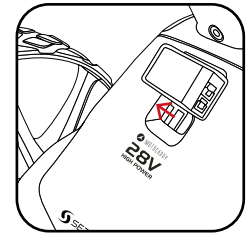

Fig 2

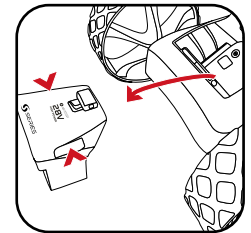

Fig 3

Recommendations for hibernation of Lithium Batteries during winter months

If for any reason your Lithium battery is not going to be used for lengthy periods, e.g. 3-months over the winter, it is advised to store the battery fully charged. Before the battery is used again, recharge it (top it up) prior to use. The battery must not be left for longer than 2-months without charging as this could invalidate your warranty.

We recognise that extended absences are not always planned in advance, however when it is likely that you will not be using your battery for a period of time it is good practice to follow these steps to extend the life of your Lithium battery. Please ensure that the charger is ALWAYS disconnected from the battery after charging.

Battery Management System (BMS)

Motocaddy Lithium batteries are fitted with a comprehensive battery management system (BMS) to protect the battery from excessive abuse, high currents, deep discharge and overcharge. When the battery is delivered there may be no output as the BMS is designed to maximize safety whilst shipping. Please ensure that the battery is fully charged prior to connecting it to your trolley as this will activate the BMS and effectively 'switch-on' the battery. From time to time, at deep discharge or long term storage the BMS may switch-off the battery. A full battery charge will rectify this problem.

Motocaddy golf trolleys are designed to work with the BMS system installed in the Lithium batteries and the battery meter is also synchronised to work in conjunction with the battery. If for any reason the voltage on the battery falls below the low battery warning on the trolley, then the BMS may disable the battery to protect it. Again if this occurs please recharge fully. Please be aware that Lithium batteries tend to 'drop off' quickly at the end of the cycle so it is not advisable to attempt to play excessive holes as the BMS will activate for protection purposes.

Attaching the Wheels / Inverting the Wheels

Attaching the Wheels

This trolley does not have a specific left and right wheel. To attach the rear wheels, follow these simple steps:

1. Push and hold the quick release button in towards the centre of the wheel
2. Slide the wheel onto the trolley axle as far as it will go (onto the inner groove)
3. Once in position, release the button and pull the wheel outwards slightly to lock
4. An audible 'click' will confirm the wheel is in the correct position

Once correctly attached onto the inner groove, non-DHC wheels will rotate freely forwards, but not backwards. DHC wheels will not rotate freely in either direction.

The outer groove can be used as a "free-wheel" option if you run out of battery power. Simply slide the wheel onto the outer groove and pull the wheel outwards slightly to lock. Once connected, the wheel will spin freely without resistance in both directions.

Inverting the Wheels

The rear wheels can be inverted to reduce the trolley width for transportation and storage.

1. Push and hold the quick release button while sliding the wheel off the axle
2. Flip the wheel over, push and hold the button, then slide onto the axle
3. Release the button and pull the wheel out slightly until it engages with the free wheel groove

It is important the wheels are not pushed on too far. They should not touch the chassis.

Adjusting the Front Wheel Alignment

In the unlikely event that your trolley is not tracking in a straight line, the alignment of the front wheel can be adjusted to rectify the fault. This problem can be caused by a number of factors including a slightly loose bag support or an unevenly packed golf bag.

To alter the alignment of the front wheel, follow these simple steps:

1. Lift the quick release lever positioned on the front wheel housing and loosen the wheel nut (fig. 1)
2. There are two small metal dials on either side of the housing that are used to realign the wheel (fig. 2)
3. If your trolley is veering to the right, you will need to turn the left hand dial clockwise and the right hand dial anti-clockwise
4. If your trolley is veering to the left, you will need to turn the right hand dial clockwise and the left hand dial anti-clockwise
5. Tighten the wheel nut and push down the lever to lock the wheel back into place (fig. 3)

This procedure can be carried out until you are happy the trolley is moving in a straight line. You may only need to adjust one dial at a time.

These instructions are based on positioning yourself in front of the trolley looking at the wheel.

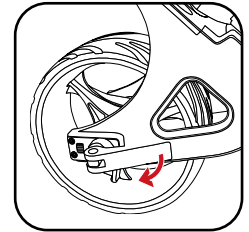

Fig 1

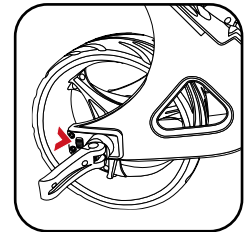

Fig 2

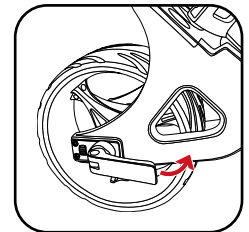

Fig 3

Unfolding your Trolley

Unfolding your Trolley

1. Position the trolley with all three wheels in contact with the ground (fig. 1)
2. Locate the red release latch positioned above the upper bag support (fig. 2)
3. Push the red release latch down while lifting the handle - the trolley will unfold in one motion (fig. 3)
4. You will hear a positive “click” when the trolley is fully unfolded (fig. 4)
5. Once unfolded, the charging port must be pushed into the battery to switch the power on (fig. 5)

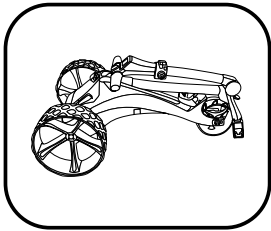

Fig 1

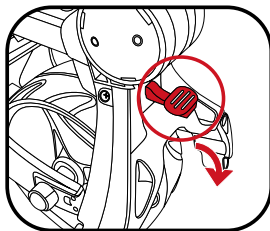

Fig 2

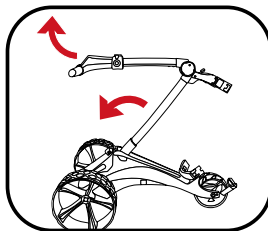

Fig 3

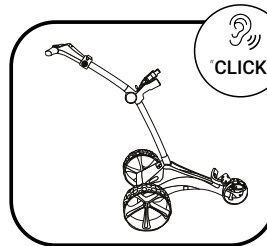

Fig 4

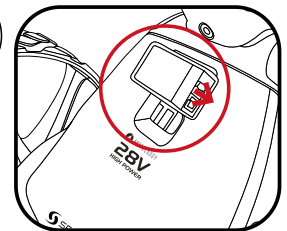

Fig 5

Folding your Trolley

1. Position the trolley in its assembled position (fig. 1)
2. Locate the red release latch positioned above the upper bag support
3. Push the red release latch away from you towards the upper bag support straps (fig. 2)
4. Lower the handle while folding the frame down and forward towards the front wheel (fig. 3)
5. You will hear a positive “click” when the trolley is fully folded (fig. 4)
6. The trolley can now be carried using the upper frame (fig. 5)

Whenever the trolley is folded with the battery installed, the power will automatically disconnect and the charging port will become accessible. This is a safety mechanism to ensure the trolley cannot accidentally be switched on when folded for storage or transportation.

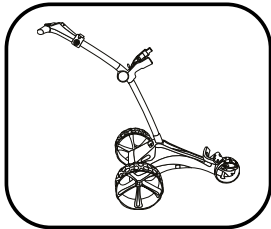

Fig 1

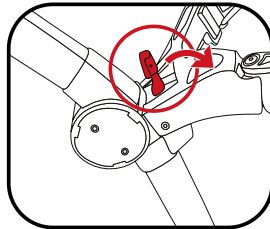

Fig 2

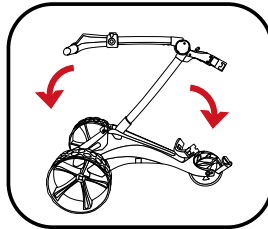

Fig 3

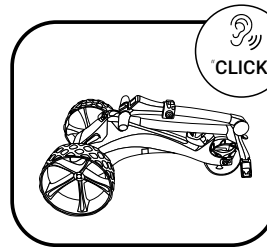

Fig 4

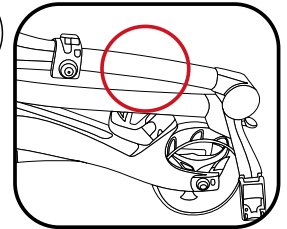

Fig 5

Lower Bag Supports

Lower Bag Support with EASILOCK™ Bag

All Motocaddy electric trolleys are fitted with the EASILOCK™ bag attachment system. This securely attaches the bag, reduces twisting and removes the need to use a lower bag strap.

1. If using an EASILOCK™ compatible bag, please ensure that the supplied pins are fitted to the bag base (fig. 1)
2. If attached, remove the two lower bag support elastic straps by pressing and holding the back of the clip before pulling outwards (fig. 2)
3. Align the cut out on the bag base with the lower bag support platform to align the bag pins with the holes on the trolley (fig. 3)
4. Lower the bag until the pins locate with the two holes. You should hear a positive “Click” as the bag locks into position

Lower Bag Support with Non-EASILOCK™ Bag

If you are using a non-EASILOCK™ golf bag, please do not remove the two lower bag support elastic straps:

1. Position your bag so it is resting on the lower bag support platform and in the cradle of the upper bag support
2. Stretch the lower bag strap around the bag base and loop the rounded bar underneath the bag support hook (fig. 4)

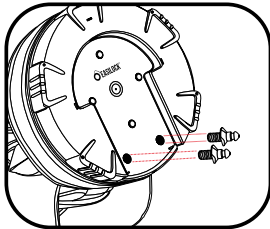

Fig 1

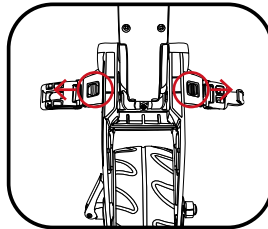

Fig 2

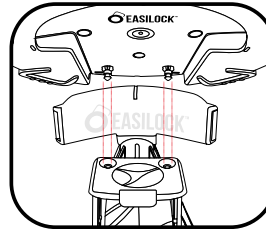

Fig 3

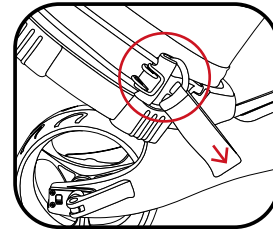

Fig 4

Upper Bag Supports

The upper bag support straps are secured in the same way as the lower straps using the following steps:

1. Stretch the elasticated strap around the bag & loop the rounded bar underneath the hook (fig. 1)
2. Position the two placement straps centrally on your golf bag (fig. 2)

Adjusting the Bag Supports

The bag support straps are manufactured from elasticated material to allow your golf bag to be held tightly in position. The strap should be adjusted to be reasonably tight around the golf bag:

1. Unclip the elasticated straps from the housing by pulling outwards in the direction shown (fig. 3)
2. Move the bar as required to tighten or loosen the strap fitting. Pulling the bar downwards will tighten, upwards will loosen (fig. 4)
3. Ensure that the straps are clipped back into the housing before use (fig. 5)

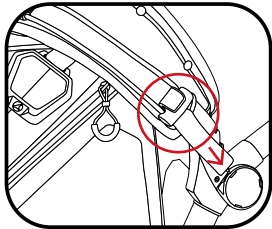

Fig 1

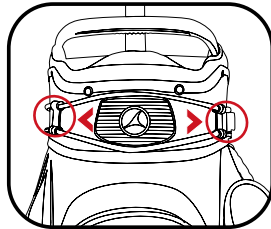

Fig 2

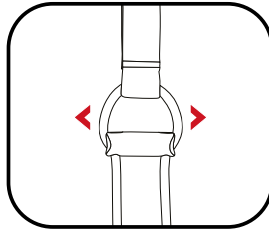

Fig 3

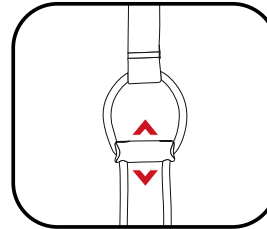

Fig 4

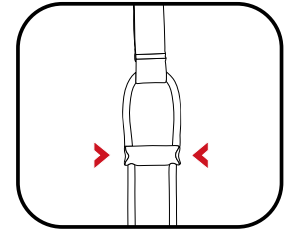

Fig 5

Starting, Stopping & Changing Speed

Starting, Stopping & Changing Speed

The S1 is very simple to control. There is one main button that is used to start and stop the trolley, whilst also controlling the speed, which can be adjusted while the trolley is stationary or in motion.

The trolley has 9 speed settings (1 to 9) with 1 being the slowest and 9 the fastest. To increase the speed, rotate the speed dial clockwise, or anti-clockwise to decrease the speed.

To start the trolley, simply select your required speed setting and press the button. The trolley will smoothly accelerate until it reaches the selected speed. To stop the trolley, simply press the button again - there is no need to reduce the speed setting.

The speed number will start flashing when you press the button. This indicates that the trolley has been started.

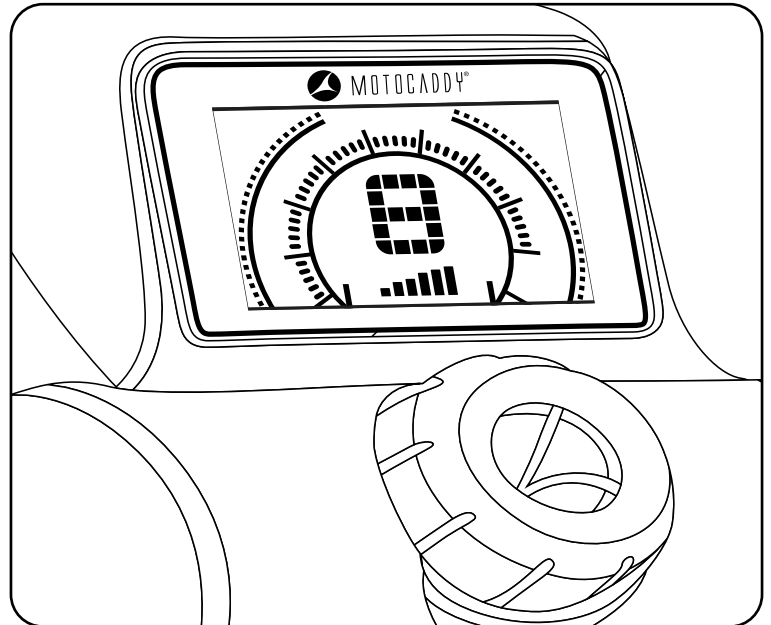

Battery Meter

The S1 includes an on-screen battery meter which provides an indication of remaining battery capacity. The number of illuminated bars will decrease as the battery capacity reduces.

A fully charged battery will show from left to right - two short red bars, two medium orange bars and two larger green bars (fig. 1).

The trolley is designed to protect your battery from being fully discharged, should your battery capacity drop too low the trolley will cut the power to the motor. If this should happen, please charge your Lithium battery before further use. It is possible to use the outer "free-wheel" groove to complete your round if required.

Please be aware that certain moisture, temperature and humidity conditions can result in localised misting within the display screen. This will not affect the trolley functionality, nor cause any damage and will return to normal when adverse conditions subside.

USB Charging Port

This trolley features a USB charging port designed to charge USB powered devices during your round.

Simply remove the covering cap and plug a USB cable into the charging port located on the underside of the handle. The device will continue charging while the cable is attached and the battery is connected.

The rate of charge will be slower than a mains AC charger and similar to plugging the device into a PC. The USB charger takes power from the main trolley battery and continuous charging will reduce the battery capacity between charges. The trolley is designed to disable the USB port when the battery capacity reaches a preset level.

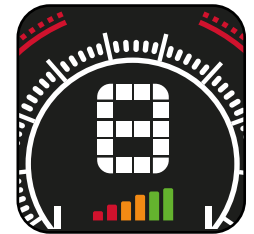

Fig 1

Adjustable Distance Control

Adjustable Distance Control

The S1 features a basic, easy to use Adjustable Distance Control which will allow you to send your trolley ahead of you from 15 - 45 yards.

1. While stationary, select the speed that you wish your trolley to set off at
2. Hold down the On/Off button for 3 seconds, the number "1" will flash on the display (fig. 1). There are three settings for the distance, 1 = 15 yards, 2 = 30 yards and 3 = 45 yards
3. Turn the button clockwise to increase and anti-clockwise to decrease to your preferred distance
4. Press the On/Off button to set the trolley in motion. While the trolley is powered using ADC, the speed number and white dashes will flash
5. The trolley can be stopped manually by pressing the button again

In the unlikely event that your trolley fails to register distance whilst in ADC mode, the trolley will cut power to the motor to prevent the trolley from travelling too far. The trolley screen will flash "E" to indicate that this safety feature has been activated (fig. 2).

The trolley can be reset by pressing the On/Off button once, thereby allowing you to continue to use the trolley with ADC disabled until you are able to contact our Technical Support team.



Fig 1

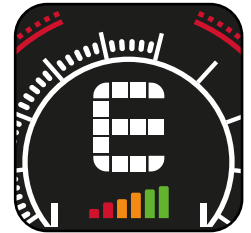

Fig 2

The below information is applicable to DHC models ONLY.

Introduction to DHC

The letters DHC stand for 'Downhill Control' and mean that your trolley will automatically maintain a controlled speed whilst travelling down hills.

Whenever you are looking to move the trolley, even if just to reposition it ready to use, always put it on a low speed setting to make it easier to steer.

Using the DHC Parking Brake

DHC models are fitted with an electronic parking brake. To use this feature, the trolley must be in a stationary position. The parking brake is initiated by rotating the speed dial down to 1 and then rotating one click further.

Once activated, the screen will toggle between 'P' and number '1' (fig. 1 & 2).

The speed setting can be adjusted whilst the parking brake is activated by turning the speed dial.

To release the parking brake, press the On/Off button to start the trolley.





Fig 1 - S1 DHC



Fig 2 - S1 DHC



 Motocaddy Ltd,
Unit 16 Stansted Distribution Centre,
Start Hill, Great Hallingbury, Hertfordshire,
CM22 7DG, United Kingdom

 +44 (0)1279 712 370

 info@motocaddy.com

 www.motocaddy.com

MC.22.61.003 | EASILOCK™ Patent (GB) - GB2519073 | USB Charging Port Patent (GB) - GB2473845 | USB Charging Port Patent (AUSTRALIA) - 2010224448